



## TATLIN

Design  
**Studio Proof**  
2016

**TATLIN** coffee tables 7TAT104 ø cm 100x41h and 7TAT101 ø 40x51h with OPM15 antique gold brushed metal base and OPP7 shiny Calacatta gold marble top and **TATLIN**

coffee tables 7TAT103 ø cm 80x41h and 7TAT102 ø cm 40x61h with OPM15 antique gold brushed metal base and OPP3 shiny Emperador brown marble top.



## TATLIN

Design  
Studio Proof  
2016

**TATLIN** dining table 7TAT125 ø cm 190x74h with OPM16 shiny brass chrome metal base and OPP7 Calacatta gold marble top. **PARIS** small chairs 9PAR103X with internal side in fabric cat. H art. Spritz Rubelli col. 18

bronzio and external side and wooden base covered in leather cat. Lusso art. Acquario col. Testa di moro. **TATLIN** table 7TAT113 ø 80x76h with OPM16 shiny brass chrome metal base and

OPP7 Calacatta gold marble top. **LOBEL** bookshelf 7LOB102 cm 180x45x185h with OPM15 antique gold brushed metal structure and OPV9 chrome back-painted bronze glass tops.





# TATLIN

Design  
**Studio Proof**  
2016

**TATLIN** table 7TAT113 ø cm 80x76h,  
7TAT116 cm 110x60x40h and console  
7TAT122 cm 160x30x80h with OPM16

shiny brass chrome metal base and OPP1  
shiny Carrara white marble top.



## TATLIN

Design  
Studio Proof  
2016

**TATLIN** dining table 7TAT126 cm 240x110x74h WITH OPP13 Velvet brown marble top and OPM16 shiny brass chrome metal base. **CHIA** small armchairs 9CHI103 cm 58x53x77h with internal side in fabric cat. H art. Spritz Rubelli col.

07 castagna and external side in leather cat. Lusso art. Acquario col. Testa di moro, with base A in OPM15 antique gold brushed metal. **FRAME** consolle 7FR130 cm 200x40x70h with OPM16 shiny brass chrome metal structure, OPP12 Velvet

07 castagna and external side in leather cat. Lusso art. Acquario col. Testa di moro, with base A in OPM15 antique gold brushed metal. **FRAME** consolle 7FR130 cm 200x40x70h with OPM16 shiny brass chrome metal structure, OPP12 Velvet brown upper marble top and OPV9 chrome back-painted bronze glass lower top. **REFLEX** mirrors 9RE106 cm 90x190 with OPM15 antique gold brushed metal frame and OPV9 chrome back-painted bronze glass.











# TATLIN

Design  
**Studio Proof**  
2016

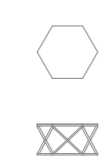
# TATLIN

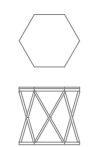
Design  
**Studio Proof**  
2016

## Tavoli Tables

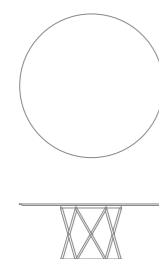
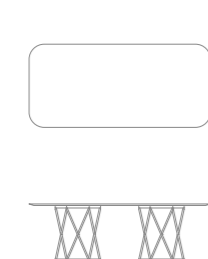
			
<b>7TAT101</b> Top in marmo Marble top <b>7TAT105</b> Top in vetro Glass top <b>7TAT109</b> Top in legno Wooden top Ø40 H51	<b>7TAT102</b> Top in marmo Marble top <b>7TAT106</b> Top in vetro Glass top <b>7TAT110</b> Top in legno Wooden top Ø40 H61	<b>7TAT103</b> Top in marmo Marble top <b>7TAT107</b> Top in vetro Glass top <b>7TAT111</b> Top in legno Wooden top Ø80 H41	<b>7TAT104</b> Top in marmo Marble top <b>7TAT108</b> Top in vetro Glass top <b>7TAT112</b> Top in legno Wooden top Ø100 H41
			
<b>7TAT113</b> Top in marmo Marble top <b>7TAT114</b> Top in vetro Glass top <b>7TAT115</b> Top in legno Wooden top Ø80 H76	<b>7TAT116</b> Top in marmo Marble top <b>7TAT117</b> Top in vetro Glass top <b>7TAT118</b> Top in legno Wooden top L110 P60 H40	<b>7TAT119</b> Top in marmo Marble top <b>7TAT120</b> Top in vetro Glass top <b>7TAT121</b> Top in legno Wooden top L134 P30 H80	<b>7TAT122</b> Top in marmo Marble top <b>7TAT123</b> Top in vetro Glass top <b>7TAT124</b> Top in legno Wooden top L160 P30 H80
			
<b>7TAT125</b> Top in marmo Marble top Ø190 H74	<b>7TAT126</b> Top in marmo Marble top <b>7TAT127</b> Top in legno Wooden top L240 P110 H74		













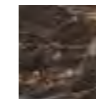
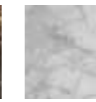
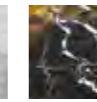
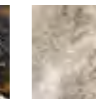

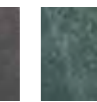
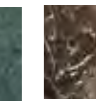







Top: rovere impiallacciato o marmo, spessore 20 mm  
Base: tubo di metallo quadrato, sezione 15 mm  
Top: oak veneer or marble, 20 mm thick  
Base: square metal tube, section 15 mm



Top in vetro extralight, temperato, spessore 6 mm  
Base: tubo di metallo quadrato, sezione 15 mm  
Top: extralight tempered glass, 6 mm thick  
Base: square metal tube, section 15 mm



## Finiture Finishes

Top in marmo Marble top									
Code	White Carrara marble <b>OPP1</b>	Black Marquina marble <b>OPP2</b>	Brown Emperador marble <b>OPP3</b>	Calacatta gold marble <b>OPP7</b>	Black and gold marble <b>OPP9</b>	Perfetto brown marble <b>OPP10</b>	Grey Stone marble <b>OPP11</b>	Guatemala green marble <b>OPP12</b>	Velvet brown marble <b>OPP13</b>
Top in legno Wooden top									
Code	Cherry stained oak <b>OPR1</b>	Wengé stained oak <b>OPR2</b>	Walnut stained oak <b>OPR3</b>	Natural oak <b>OPR4</b>	Black stained oak <b>OPR5</b>	Cherry Milano stained oak <b>OPR6</b>			
Code	Tobacco stained oak <b>OPR8</b>	Grey taupe stained oak <b>OPR9</b>	Whitened oak <b>OPR10</b>	Charcoal stained oak <b>OPR11</b>	Mahogany stained oak <b>OPR12</b>	Moka matt stained oak <b>OPR15</b>			
Top in vetro Glass top									
Code	RAL 9016 traffic white back-painted glass <b>OPV3</b>	RAL 9017 traffic black back-painted glass <b>OPV4</b>	RAL 7044 silk grey back-painted glass <b>OPV5</b>	RAL 1019 grey beige back-painted glass <b>OPV6</b>	Chrome back-painted bronze glass <b>OPV9</b>	Chrome back-painted grey glass <b>OPV10</b>			
Base in metallo Metal base									
Code	Shiny chrome metal <b>OPM1</b>	Brushed matt chrome metal <b>OPM2</b>	Brushed matt dark grey metal <b>OPM3</b>	Classic bronze painted metal <b>OPM9</b>	Golden beach painted metal <b>OPM10</b>	Gold pearl painted metal <b>OPM11</b>			
Code	Brushed copper metal <b>OPM12</b>	Brushed antique brass metal <b>OPM13</b>	Shiny black chrome metal <b>OPM14</b>	Brushed antique gold metal <b>OPM15</b>	Shiny brass chrome metal <b>OPM16</b>	Bronze metal <b>OPM17</b>			